

Data Sheet



Article number: 12621000160000

Description: Industrial tool 621 000 160.000
For M16

Measures

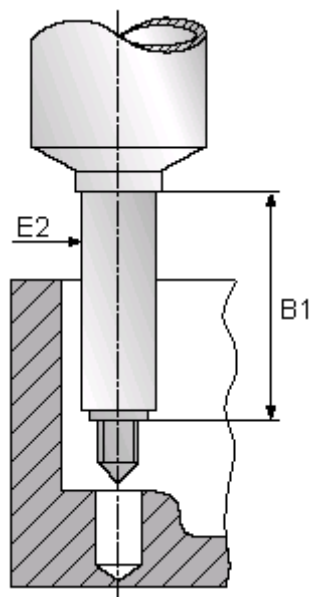

B1	= 60
E2	= 22
For thread	= M16